



## **⚠ IMPORTANT SAFETY INSTRUCTIONS FOR INSTALLATION**

### **WARNING – INCORRECT INSTALLATION CAN LEAD TO SEVERE INJURY FOLLOW ALL INSTALLATION INSTRUCTIONS**

Before installing the operator check that the door is in good mechanical condition, and correctly balanced, and that it opens and closes properly.

- Do not use the force adjustments to compensate for a binding or sticking garage door. Excessive force will interfere with the proper operation of the Safety Reverse System or damage the garage door.
- Do not wear rings, watches or loose clothing while installing or servicing a garage door operator.
- To avoid serious personal injury from entanglement, **remove any ropes** connected to the garage door before installing the door operator.
- Install a remote mounted push button within sight of the door but away from any moving parts and at a height of at least 1.5 metres.
- **The safety reverse system test is very important.** The garage door must reverse when obstructed on closing. **Failure to properly adjust the operator may result in serious personal injury from a closing garage door.**

Installation and wiring must be in compliance with your local building and electrical codes.

- If the garage has no service entrance door then an exterior release kit **MUST** be fitted. This accessory allows manual operation of the garage door from outside in case of power failure.
- Disconnect electric power to the garage door operator before making repairs or removing covers.
- Use the manual release lever to disengage the motor drive **ONLY** when the drive is switched OFF and, if possible, when the door is fully closed.
- Examine the installation, in particular the cables, spring and mountings, for signs of wear, damage or imbalance. Do not use if repair or adjustment is needed since a fault in the installation or an incorrectly balanced door may cause injury.

### **IMPORTANT SAFETY NOTE**

Only operate the door when the door is in full view, free of obstacles with no persons (particularly children) near the door. Nobody should be allowed to enter or leave the garage whilst the door is in motion.



## SAFETY FEATURES

- **Automatic Door Reverse**  
An unmodified closing door will automatically reverse within 2 seconds if door is obstructed by person or object.
- **Automatic Time Reverse**  
Closing door will automatically reverse if the door is not fully closed within 88 seconds.
- **Safety Stop**  
Opening door will immediately stop when obstructed by person or object.
- **Beam Break**  
For additional safety we recommend a Beam Break is installed. If the INFRARED BEAM is broken by a person or object whilst the door is closing, it will automatically reverse to the fully open position without actually having touched the closing door itself.

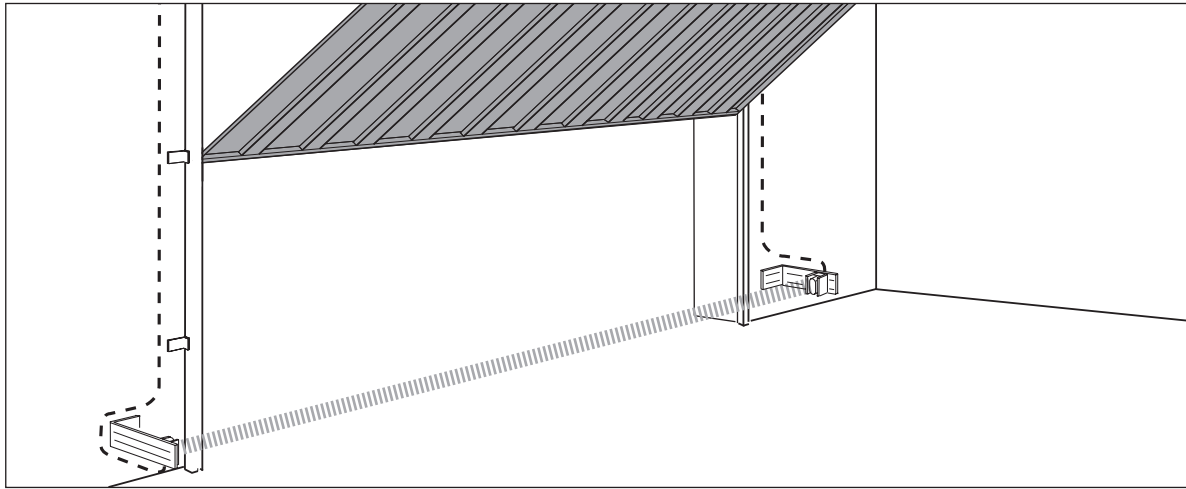

## OPERATOR ASSEMBLY

### Note:

Where the operator has been specified with a 2-piece boom, please refer to the assembly instructions for this item supplied with the boom.

- 1 Install grey motorshaft adapter onto motorshaft.  
Bolt rail with brackets and screws to motorhousing.  
Make sure the screws are tightly fastened.

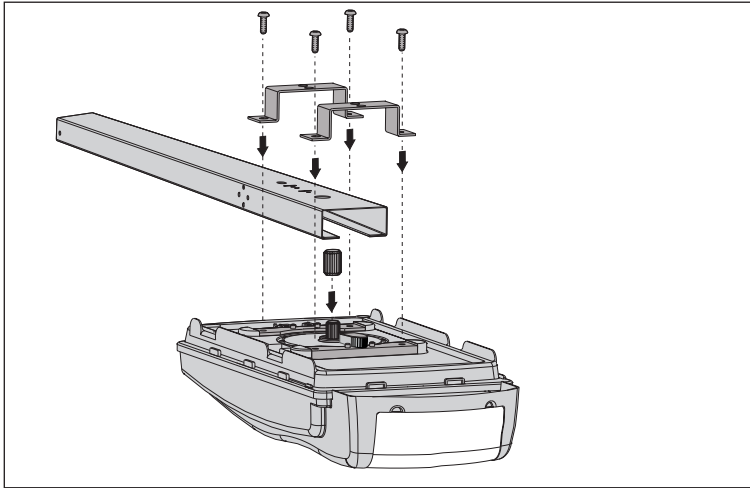

- 2 Fit the red slider that re-engages the emergency release and operator pull bar onto carriage.
  - a. Refer to fig.1 to fit the red slider that re-engages the emergency release knob onto carriage.
  - b. Refer to fig.2 to fit pull bar onto carriage. Note position of emergency release cord to ensure correct cord position after installation.

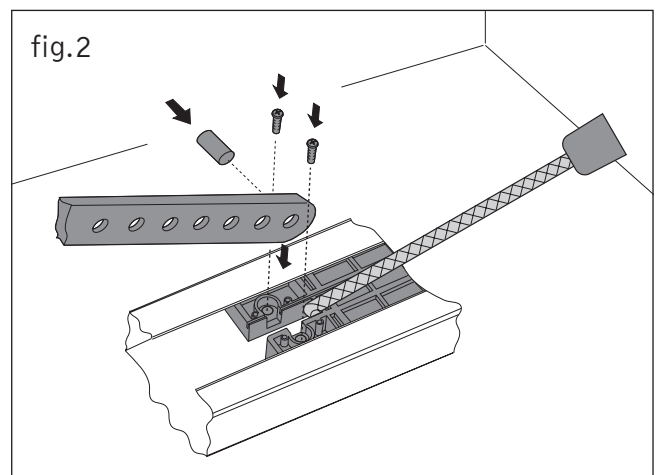
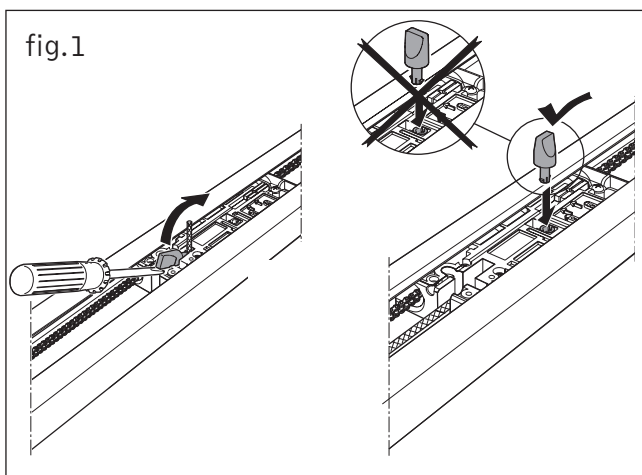

### 3 Carriage quick release.

- a. Pull cord "a" to disengage. Carriage re-engage remain disengaged. See fig. 3
- b. Move red slider "b" in direction of arrow to re-engage carriage at next movement. Start operator. See fig. 4.

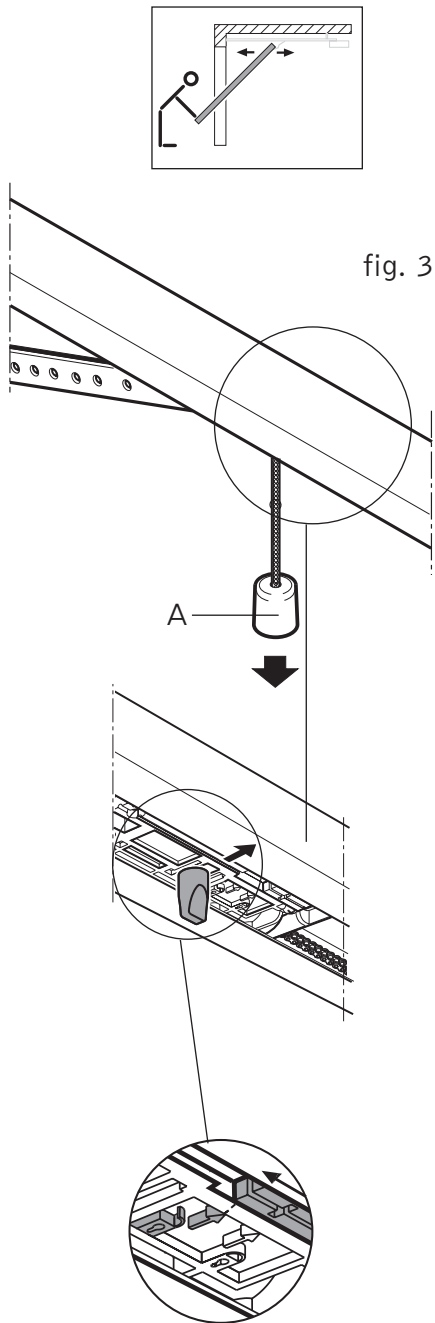

fig. 3

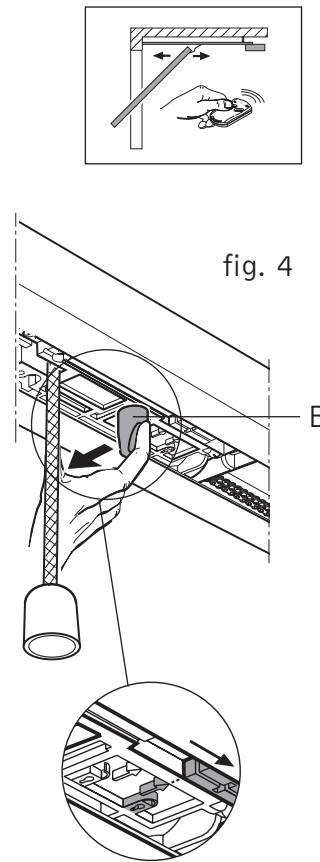

fig. 4

## OPERATOR INSTALLATION

### DETERMINE GARAGE DOOR TYPE

Determine your garage door type as indicated in Step **4A**, **4B**, **4C** or **4D**. Follow the individual instructions required for your specific garage door type. If your garage door type is not included, please contact your distributor. Special accessories or operator modifications may be required.

#### **4A** 1-Piece up-and-over doors

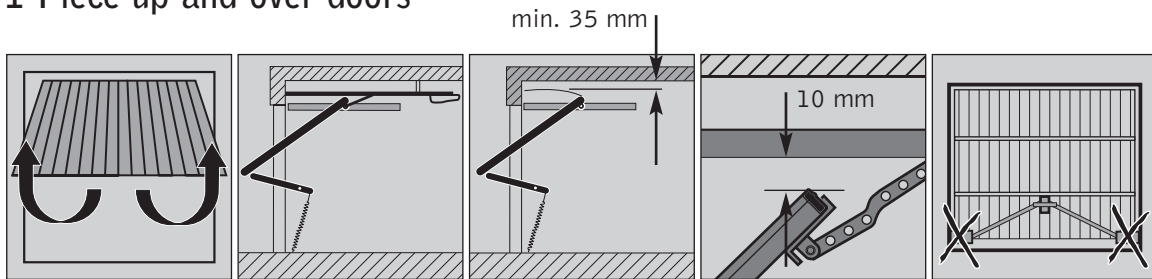

- Install door bracket at centre position of door and rail bracket on centre position above door. Make sure there is at least 10 mm. clearance between highest travel point of door and rail.

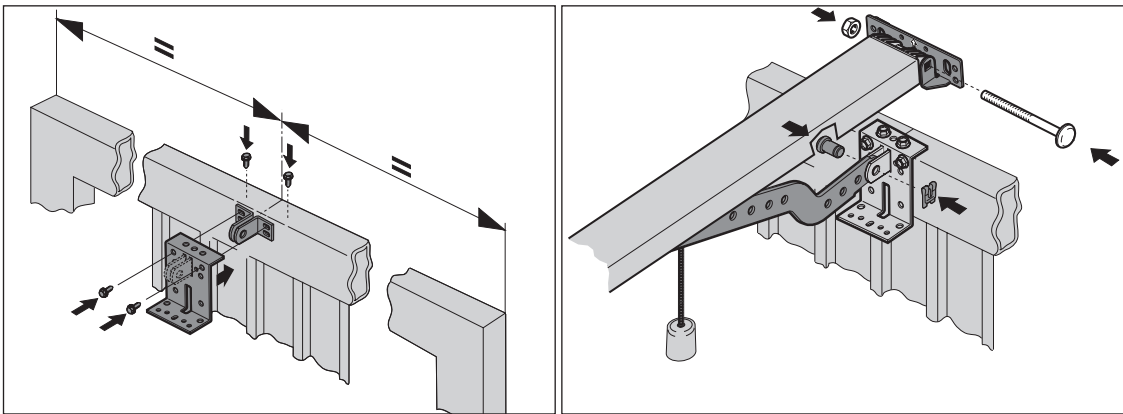

- Level and mount operator.

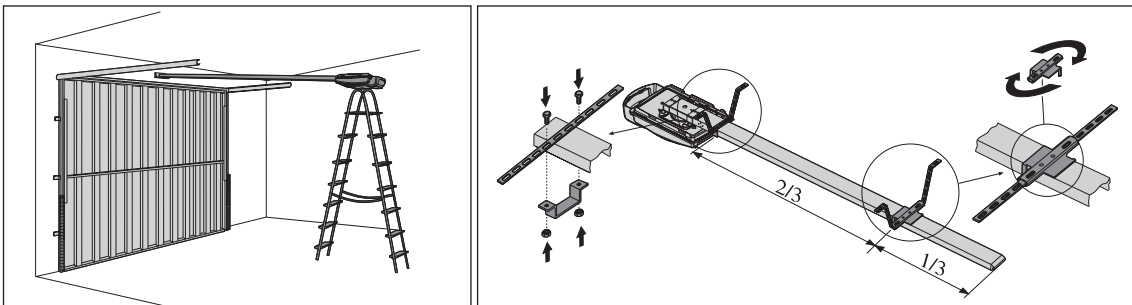

- Disengage carriage from chain or belt! Door may only be moved with moderate speed.
- Connect operator pull bar to door bracket.

#### **Note:**

Remove or disable all door locks before installation!

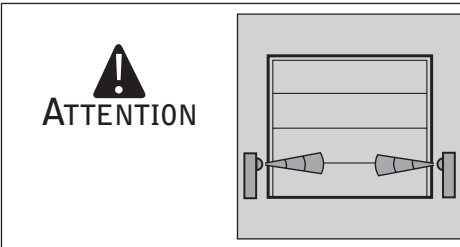
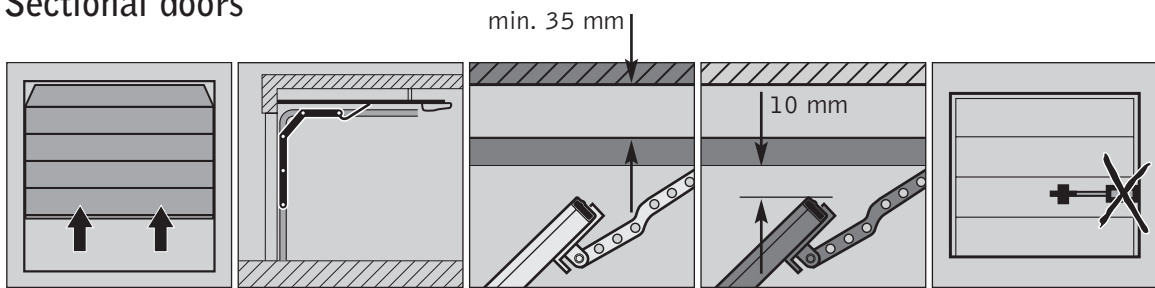
**4B****Sectional doors**

A beam break is strongly recommended for use with sectional doors (available separately).

- Fix adjustable door bracket to top section at the centre of the door.

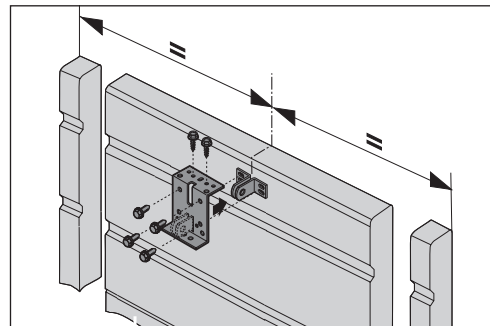

- Install rail bracket on centre position above door. Make sure there is at least 10 mm clearance between highest travel point of door and rail.

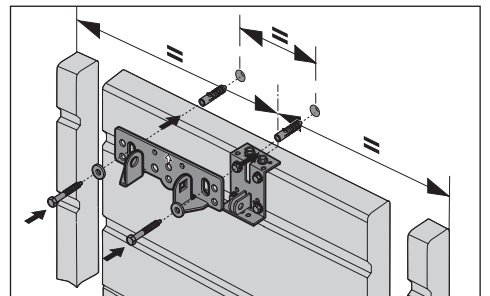

- Level and mount operator.

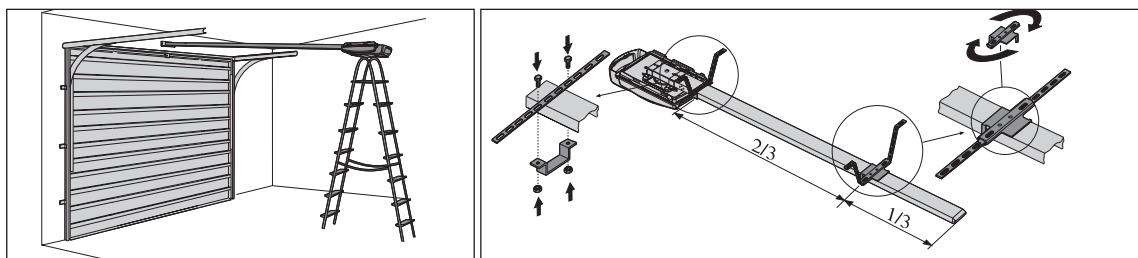

- Disengage carriage from chain or belt. Door may only be moved with moderate speed.
- Connect operator pull bar to door bracket.

**Note:**

Remove or disable all door locks before installation!

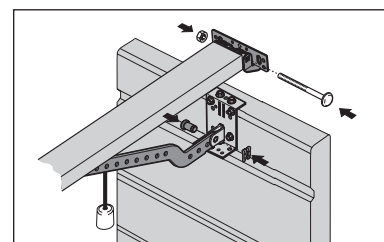

#### 4C Retractable non-protruding up-and-over doors

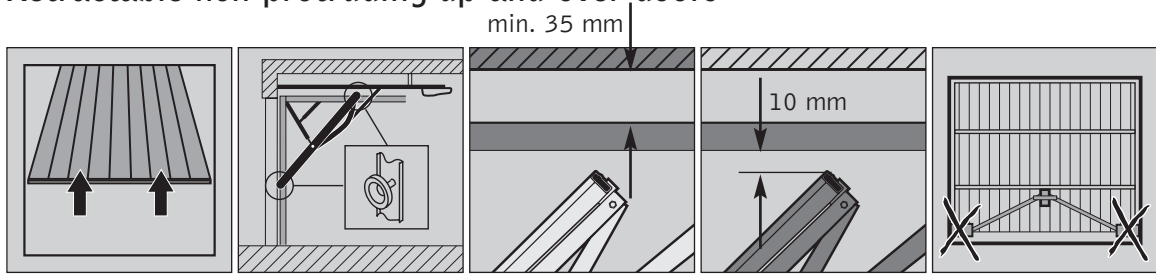



**ATTENTION**

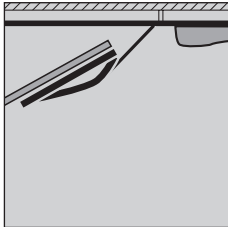
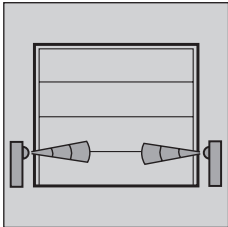

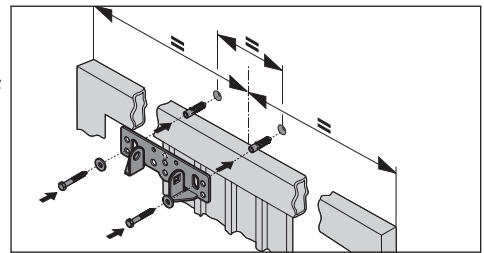

Special adapter arm (curved door arm) is required.  
An optical sensor is strongly recommended (not included; have to be ordered separately).

- Install rail bracket on center position above door. Make sure there will be at least 10 mm. clearance between highest travel point of door and rail.

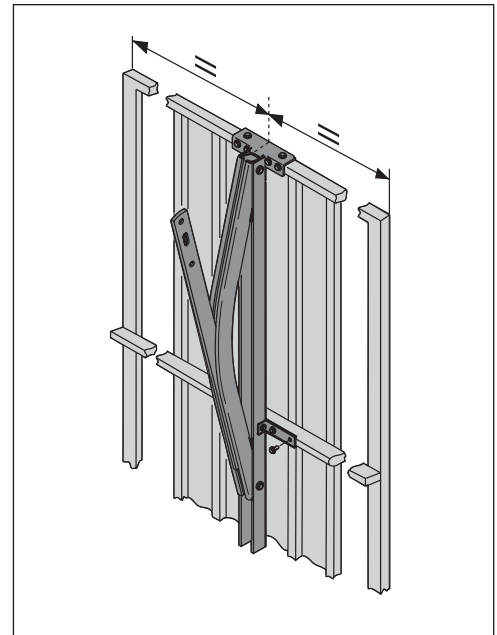

- Fit the adapter arm (curved door arm) according to instructions of adapter arm supplier.



- Level and mount operator.

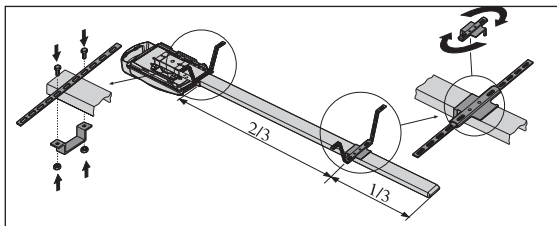
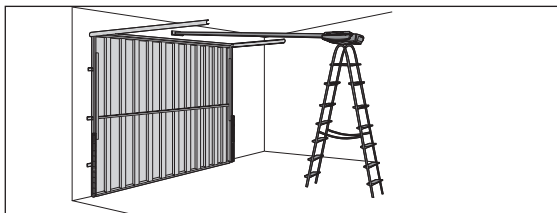

- Disengage carriage from chain or belt! Door may only be moved with moderate speed.
- Fully open garage door and connect pull bar to adapter arm. Manually close door and check if the minimum door-carriage distance of 165 mm. has not been exceeded.

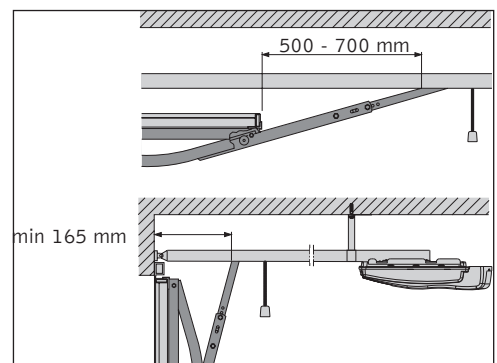

## 4D Vertically tracked canopy doors

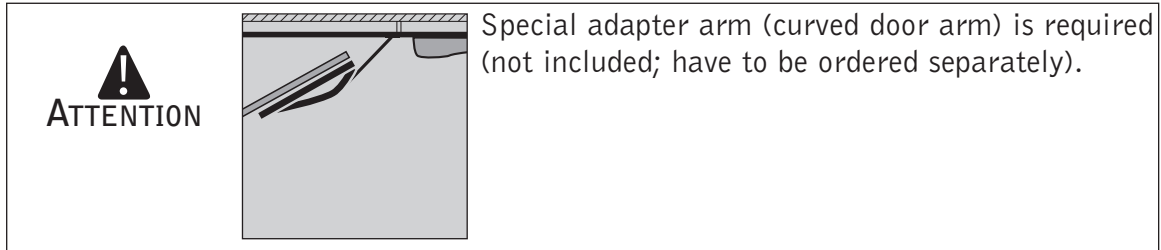
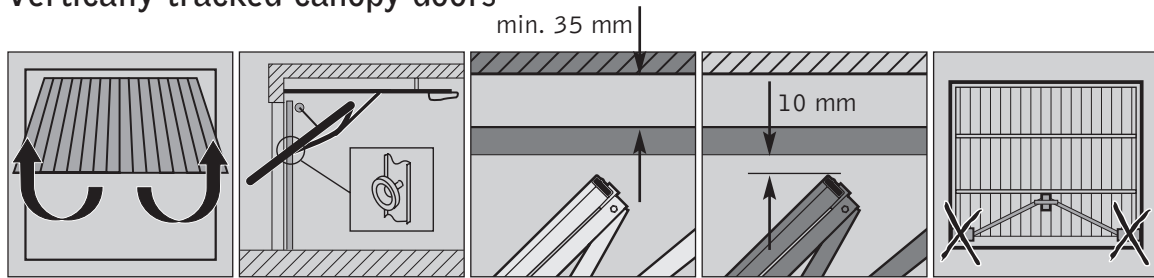

- Install rail bracket on center position above door. Make sure there will be at least 10 mm. clearance between highest travel point of door and rail.

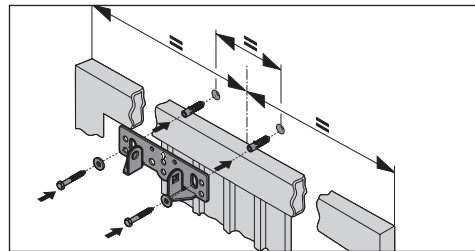

- Fit the adapter arm (curved door arm) according to instructions of adapter arm supplier.
- Level and mount operator.

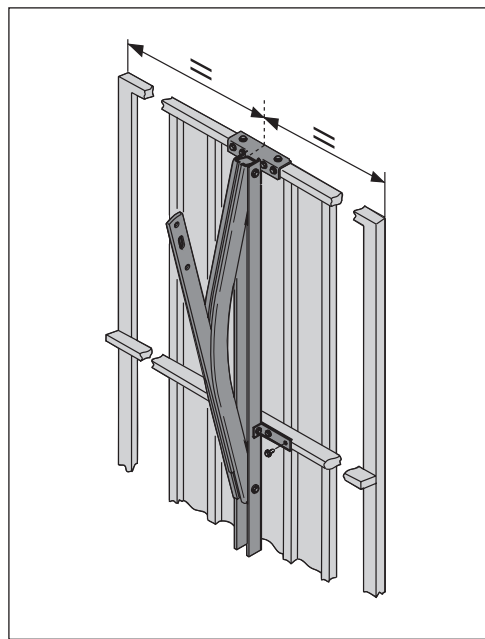
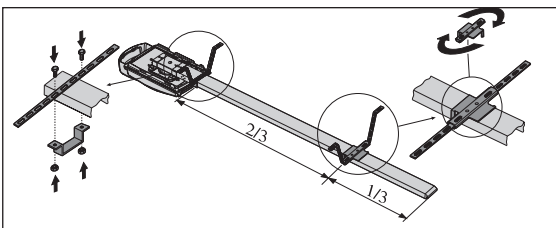
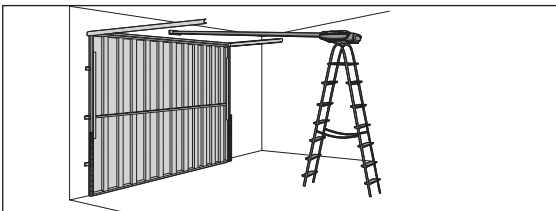

- Disengage carriage from chain or belt! Door may only be moved with moderate speed.
- Fully open garage door and connect pull bar to adapter arm. Manually close door and check if the minimum door-carriage distance of 165 mm. has not been exceeded.

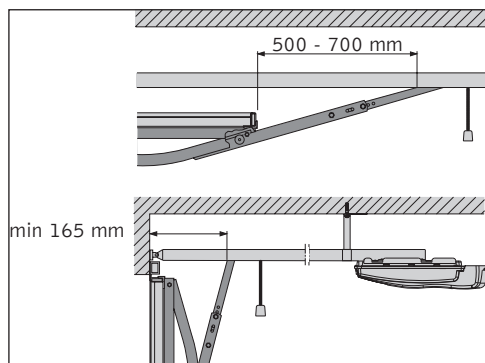

FOR ALL OTHER DOOR TYPES PLEASE CONTACT YOUR DISTRIBUTOR!





- 5 Make sure motorhousing and rail are mounted correctly and secured.  
Strengthen where needed.
- 6 Install light bulb.  
Type E14, max. 40 Watt (not included).

**!** Attention: before you start Operator programming please make sure your carriage is engaged to chain or belt and door arm is attached to door.



## OPERATOR CONTROL PANEL INDICATIONS

Your automatic door operator is provided with an easy to read LED display panel with 4 light icons and three program buttons.





### Light icons:

-  1 door fully open
-  2 door fully closed
-  3 Malfunction or vacation lock. Check error message by pressing  briefly
-  4 power on (230V)

### Adjustment buttons

-  Program button "decrease" and CLOSE test button
-  Program button "increase" and OPEN test button
-  Programming button

### LEGEND

LED off i.e.   
LED illuminated i.e.   
LED blinking i.e.   
LED rapid blinking i.e. 

Button pressed  or  or 

Default setting:

i.e.



## PROGRAMMING OVERVIEW MODEL O-NR SERIES II

Menu	Basic Settings
Menu ①	Programming 'door open position'
Menu ②	Programming 'door closed position'

Level 2	Advanced Settings	Explanation	Factory Settings
Menu ①	Add beam break (photocell)	Setting whether the operator runs with or without photocell	no photocell existing
Menu ②	Set maximum OPENING force	The sensitivity of power limit can be set in steps from 1 - 8	6/8
Menu ③	Set maximum CLOSING force	The sensitivity of power limit can be set in steps from 1 - 8	4/8
Menu ④	Set 'offset' learned power limit (sensitivity)	The sensitivity of power limit can be set in steps from 1 - 15	7/15
Menu ⑤	Set start-up warning phase	Setting whether a signal light will flash before the door starts to move with a delayed door start	warning before start deactivated
Menu ⑥	Set 'operator speed'	The speed the door is moved by the operator can be set	8/8 (max. speed)

## PREPARATION FOR PROGRAMMING

- The operator has to be mounted ready for operation
- The door is not yet closed completely
- If there is a beam break (photocell), it should be connected!





### Advice:

If the photocell is correctly mounted and aligned, the function 'photocell' is recognized automatically during programming!

- If applicable, before programming the operator, stick battery into your hand transmitter(s).
- When the door operator is turned on (plug in power cord) it runs a self-test; all 4 LEDs will glow and operator 230V light will illuminate for approximately 2 seconds. When the light is off and LED **4E** is illuminated the operator is in normal operating mode.



### ADJUSTMENT BUTTONS:

All settings and adjustments can be made with the three adjustment buttons.

Use  and  to change settings of chosen program menu  
 to store menu setting and go to next menu.



### Advice:

The programming is cancelled if none of the three buttons (, , ) is actuated during a time period of more than 120 sec.

All functions saved before with button  remain unchanged.

When programming is cancelled, LED **3E** is flashing.

After shortly pressing button  the error message 1 is displayed.



### Attention:

The operator has **two** programming levels.

For normal operation of the operator you only program the end positions.

**Changes in the extended programming level may only be carried out by specialists.**



### Advice:

To determine the error number add the figures of the irregularly flashing LED's.

See as well 'error messages'.

In case of a malfunction the control light MALFUNCTION **3E** is flashing.

- Shortly press button  .  
-> The current error number is displayed by irregularly flashing LED's (e.g. error **3E** and **1E**).

**Advice:**



The end positions can only be programmed if there is a valid reference point.  
For this travel the door electrically once to open or close position.

**Display of the reference point**

The operator passes the reference point sensor:

- LED  shortly glows up.

**Advice:**

All menus can be reset by a RESET function to the original values set by factory.  
Reset is activated by pressing ,  and  together for more than 30 seconds.

## OPERATOR PROGRAMMING - BASIC SETTINGS

### MENU OVERVIEW:

- 1 Set door OPEN position
- 2 Set door CLOSED position

### To SET UP THE OPERATOR:

#### Menu 1

SET DOOR OPEN POSITION 

1. Press **OP** for 2 seconds until LED  blinks and all others are illuminated.
2. To move the garage door to desired fully OPEN position press & hold the  until desired DOOR OPEN position is reached.  
For fine-tuning use the  (OPEN) and  (CLOSE) buttons.



#### Advice:





The reference point has to be passed 1x.

 will light up briefly when reference point has to be passed 1x.

3. Press **OP** to store and to go to Menu 2.

#### Menu 2

SET DOOR CLOSE POSITION 



1. LED  blinks and all others are illuminated.
2. To move the garage door to desired fully CLOSED position press & hold the  until desired DOOR CLOSE position is reached.  
For fine-tuning use the  (CLOSE) and  (OPEN) buttons.



#### Advice:



The reference point has to be passed 1x.

 will light up briefly when reference point has to be passed 1x.

3. Once door position is correct press **OP** to store and to finish basic programming.  
LEDs will automatically turn off starting at LED  and ending at LED 2.  
The operator is now in operational (normal) mode .

### MAKING ADJUSTMENTS:

To change the settings of an individual menu:

1. Press **OP** for approximately 2 seconds until LED blinks
2. Repeatedly press **OP** until desired indicator blinks.  
If an individual programming menu is skipped its settings remain unchanged.
3. Follow individual instructions for Program menu
4. Repeatedly press **OP** to scroll through the menus. When you reach last menu by pressing **OP** the LEDs will automatically turn off starting at LED  and ending at LED .

# EXTERNAL CONNECTIONS

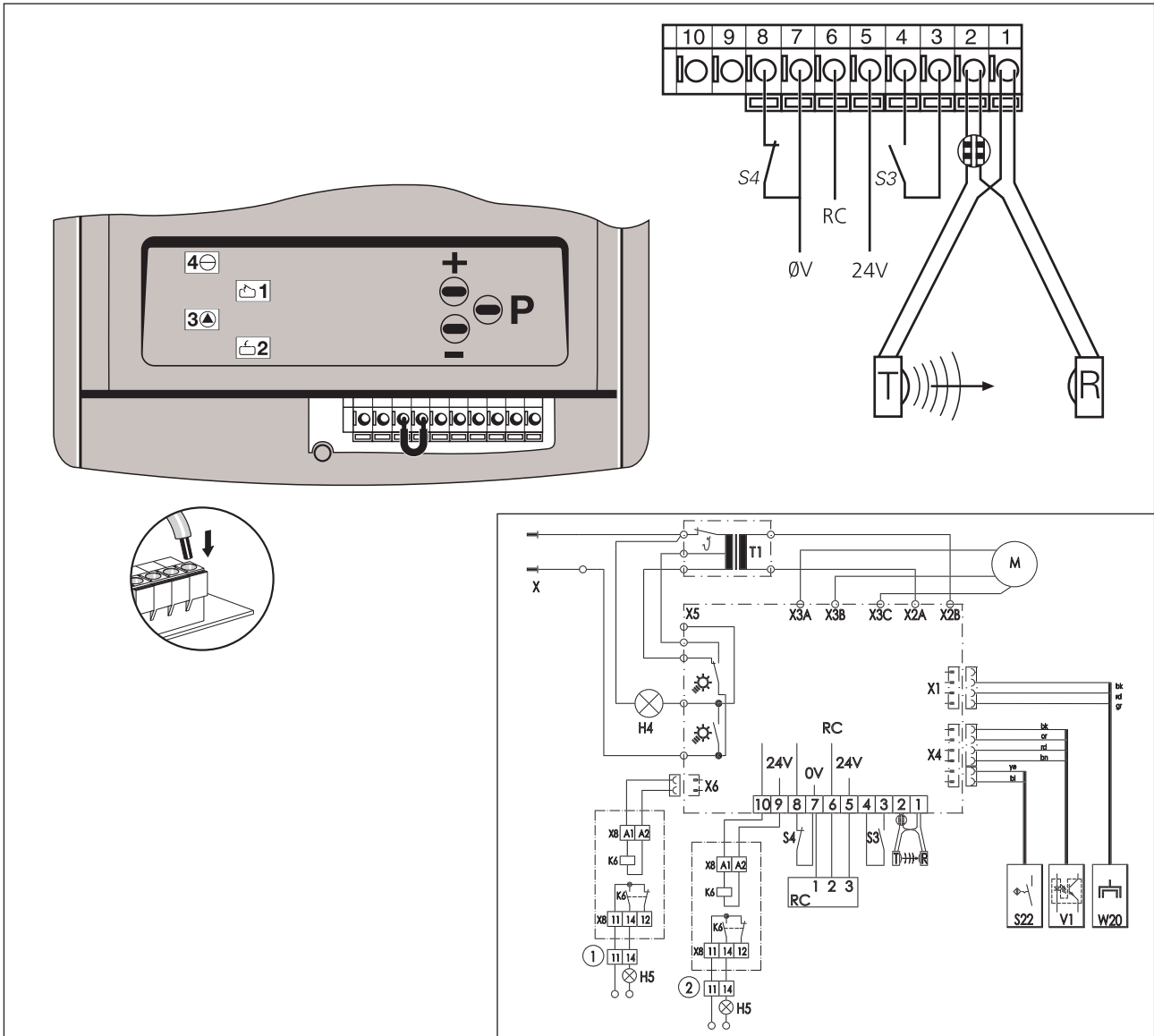

- X1 4 pin connector for receiver (option) or diagnose
- X4 6 pin connector RPM sensor and reference switch
- X5 5 pin connector transformer and light
- X6 2 pin connector external relay
- X3A flat cable connector motor (gr)
- X3B flat cable connector motor (bn)
- X3C flat cable connector ground (gr/ye)
- X2A flat cable connector 24VAC (bn)
- X2B flat cable connector 24VAC (bl)
- X plug 1~N 220-240V 50Hz
- M motor
- T1 transformer
- V1 RPM sensor
- S22 reference point switch
- W20 receiver module (optional)
- H4 operator light
- H5 external signal light
- ① internal relay (optional)
- ② external relay (optional)

- 0V masse (ground)
- RC contact
- 24V 24VDC, 50mA max
- bk black
- bn brown
- or orange
- rd red
- gr green
- bl blue
- ye yellow

### Wall control (push button impulse):

It is possible to either connect a push button or a 3-function wall console with impulse, light on/off and an electronic vacation lock functions. When operator LED 4 burns and LED 3 flashes the 'vacation' lock is actiated. De-activate 'vacation' lock on 3-function wall console or by briefly pressing **EP** button on operator.

## TROUBLESHOOTING

Fault	Cause	Remedy
Indicator 4 does not glow.	No voltage.	Check mains supply. Check electric socket.
	Thermal protection in mains transformer activated.	Allow mains transformer to cool down.
	Defective control unit.	Cut off mains supply to operator. Remove lamp cover and motor cover. Unscrew control unit, pull slightly forward and withdraw the connecting plug. Remove control unit and have it checked.
Indicator 3 flashes. Error 5 or 8	Automatic cut-out set too sensitively. Door operation too sluggish. Door blocks.	Re-set automatic cut-out to be less sensitive (Level 2, Menu 2 and 3 page 20). Ensure door moves easily.
Indicator 3 flashes. Error 3 or 7	External photocell defective or interrupted.	Remove obstruction or have photocell checked.
Drive only operates in "OPEN" but not in "CLOSE" direction. Error 7	Photocell programmed, but not connected (Level 2, Menu 1 page 20).	Reprogramme photocell function or connect photocell.
No response on impulse. Indicator 3 glows.	Connecting terminals for "IMPULSE" button bridged, e.g. due to short-circuit or wrong terminal connection.	Temporarily isolate cabled key switches or interior push buttons from control unit. Remove plug, insert plug and look for cable fault.
No response on impulse. Error 10	Short-circuit label removed, but "STOP" button not connected.	Connect "STOP" button.
Indicator 4 flashes. Error 4	RPM sensor defective.	Have operator checked.
	Door too sluggish.	Check door.
Transmitter command does not respond but wall control does (LED 4 on, LED 3 flashes)	Operator is in electronic 'vacation' lock	De-activate 'vacation' lock on 3-function wall console or by briefly pressing <b>EP</b> button on operator.

## ERROR MESSAGES

When LED **3** is flashing the error message can be retrieved by pressing **OP** briefly.

The total sum of numbers in blinking LEDs indicate the so-called error number.

LED flashes erratically	Error number	Fault
<b>3</b>	3	Photocell actuated
<b>1</b>	1	Programming aborted
<b>2</b>	2	Reference point switch defective
<b>4</b>	4	Defective RPM sensor Anti-lock system actuaed
<b>4</b> + <b>1</b>	5	Power limit is active
<b>4</b> + <b>3</b>	7	Excess travel stop
<b>4</b> + <b>3</b>	7	Photocell self-monitoring unit not o.k.
<b>4</b> <-> <b>3</b>	7	Voltage monitoring is active
<b>4</b> + <b>3</b> + <b>1</b>	8	Power limit self-monitoring unit
<b>4</b> + <b>3</b> + <b>1</b>	8	Learned power limit
<b>4</b> + <b>3</b> + <b>1</b>	8	Response sensitivity of power limit
<b>4</b> + <b>3</b> + <b>2</b> + <b>1</b>	10	NC contact (Terminal 7&8) broken



### Attention:

Programming the advanced features of this operator must only be undertaken by fully trained and qualified personnel. Please contact your dealer for details.

## Level 2 ADVANCED SETTINGS

### MENU OVERVIEW **Level 2** :

- ① Add beam break (photocell)
- ② Set maximum OPENING force
- ③ Set maximum CLOSING force
- ④ Set offset learned power limit (sensitivity)
- ⑤ Set start-up phase
- ⑥ Set "operator speed"



### Advice:

The values for the automatic cut-out (= max. force) and learning power limit (= power curve) can be set manually in the 2nd programming level.

A setting should always be carried out as soon as a less sensitive setting has to be chosen due to door travel properties caused by site conditions, as otherwise the automatic cut-out or power limit would react and cause malfunctions.

In general you have to take care that the allowed operating forces according to EN 12445 and EN 12453 are not exceeded.



### Advice:

The setting of the automatic cut-out corresponds to the maximum power of the operator. At the first travel to OPEN or CLOSE direction after 'POWER ON' the automatic cut-out is effective according to the adjustment. For further travels the self-learned power, that is more sensitive, is effective. The automatic cut-out is still the upper limit of power.











## To SET UP ADVANCED SETTINGS:

### Level 2 Menu 1

#### ADD BEAM BREAK\*

\*Beam break is an optional accessory.

Operator is in normal operating mode.

1. Press  for 10 seconds until LED  flashes rapidly and all others are illuminated.
2. Release  where after LED  blinks and all others are illuminated.
3. A. Press  if a beam break is to be installed (LED  illuminated)  
B. Press  if no beam break is to be installed (LED  blinks rapid)
4. Press  to store settings and to go to Menu .

### Level 2 Menu 2

#### SET MAXIMUM OPENING FORCE AND



#### Attention:

The automatic cut-out is set automatically.  
Only change it if necessary (error No. 5).

When increasing the set value the max. force in OPEN direction is increased and thus the sensitivity of the automatic cut-out is reduced.







#### Attention:

































Always test the max. allowed operating forces according to EN 12445 and EN 12453!



#### Advice:

The setting of the automatic cut-out corresponds to the maximum power of the operator. At the first travel to OPEN or CLOSE direction after 'POWER ON' the automatic cut-out is effective according to the adjustment. For further travels the self-learned power, that is more sensitive, is effective. The automatic cut-out is still the upper limit of power.

1. LED  and LED  blink and all others are illuminated.
2. By pressing  and  set the desired maximum lifting force.  
Each illuminated LED represents 1/8 of the maximum total force.

    1/8	    2/8	    3/8	    4/8	    5/8	    6/8	    7/8	    8/8
---	---	---	---	---	---	---	---

3. Once maximum opening force is set press  to store and go to Menu .



#### Attention:

When re-programming the end positions (1st programming level) the opening force is learned once more.

With new setting of the end positions the force values are determined automatically.

Depending on the door travel properties increasing of the force values may be necessary.



**Attention:**

The automatic cut-out is set automatically.  
Only change it if necessary (error No. 5).

When increasing the set value the max. force in OPEN direction is increased and thus the sensitivity of the automatic cut-out is reduced.







**Attention:**

Always test the max. allowed operating forces according to EN 12445 and EN 12453!



**Advice:**

The setting of the automatic cut-out corresponds to the maximum power of the operator. At the first travel to OPEN or CLOSE direction after 'POWER ON' the automatic cut-out is effective according to the adjustment. For further travels the self-learned power, that is more sensitive, is effective. The automatic cut-out is still the upper limit of power.

1. LED  and LED  blink and all others are illuminated.
2. By pressing  and  set the desired maximum closing force.  
Each illuminated LED represents 1/8 of the maximum total force.

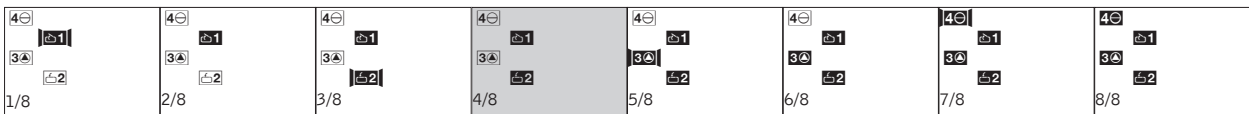

3. Once maximum opening force is set press  to store and go to Menu 4.



**Attention:**

When re-programming the end positions (1st programming level) the closing force is learned once more.

With new setting of the end positions the force values are determined automatically.

Depending on the door travel properties increasing of the force values may be necessary.

**Level 2** Menu **4**

SET OFFSET AUTOMATIC LEARNED POWER LIMIT **3**



**Attention:**

The learning power limit is set automatically.  
Only change it if necessary (error No. 8).

When increasing the set value the offset in OPEN and CLOSE direction is increased and thus the sensitivity of the learning power limit is reduced.



**Attention:**

Always test the max. allowed operating forces according to EN 12445 and EN 12453!

1. LED **3** blinks and all others are illuminated.
2. Use  $\uparrow$  or  $\downarrow$  to change offset in increments of 1/16 of the maximum.  
minimum offset: 1/15  
maximum offset: 15/15

4 3 2 deakti- vated	4 3 2 1/15	4 3 2 2/15	4 3 2 3/15	4 3 2 4/15	4 3 2 5/15	4 3 2 6/15	4 3 2 7/15	4 3 2 8/15	4 3 2 9/15	4 3 2 10/15	4 3 2 11/15	4 3 2 12/15	4 3 2 13/15	4 3 2 14/15	4 3 2 15/15
---------------------------------	---------------------	---------------------	---------------------	---------------------	---------------------	---------------------	---------------------	---------------------	---------------------	----------------------	----------------------	----------------------	----------------------	----------------------	----------------------

3. Press **P** to store and go to Menu **5**.

**Level 2** Menu **5**

SET START-UP PHASE **4**

1. Make sure LED **4** is blinking and all other are illuminated.
2. Use  $\uparrow$  or  $\downarrow$  to change start-up warning phase.
  - a. No start-up warning
  - b. 2 second start-up warning with external signal relay blinking
  - b. 2 second start-up warning with external signal relay illuminated

There are 3 settings; blinking LED **1** represents A; illuminated LED **1** represents B and illuminated LED **1** and blinking LED **2** represents C.

4 3 2 A	4 3 2 B	4 3 2 C
------------------	------------------	------------------

3. Press **P** to store and go to Menu **6**.

## Level 2 Menu 6

SET "OPERATOR SPEED" **3▲** AND **4⊖**

1. LED **3▲** and **4⊖** blinks rapidly and all others are illuminated.
2. Use **+** or **-** to change the operator speed in steps of 2/8 to 8/8 (factory settings).  
minimum speed: 3/8  
maximum speed: 8/8

<b>4⊖</b> <b>3▲</b> <b>1</b> <b>2</b> 1/8	<b>4⊖</b> <b>3▲</b> <b>1</b> <b>2</b> 2/8	<b>4⊖</b> <b>3▲</b> <b>1</b> <b>2</b> 3/8	<b>4⊖</b> <b>3▲</b> <b>1</b> <b>2</b> 4/8	<b>4⊖</b> <b>3▲</b> <b>1</b> <b>2</b> 5/8	<b>4⊖</b> <b>3▲</b> <b>1</b> <b>2</b> 6/8	<b>4⊖</b> <b>3▲</b> <b>1</b> <b>2</b> 7/8	<b>4⊖</b> <b>3▲</b> <b>1</b> <b>2</b> 8/8
--	--	--	--	--	--	--	--

3. Press **⊖P** to store and to finish setting up the operator speed and level 2 settings.

The LEDs will automatically turn off starting at LED **4⊖** and ending at LED **1**.  
Operator is now in operational (normal) mode (recognizable by illuminated LED **4⊖**) and possible LED **1** (door fully open) or LED **2** (door fully closed).

## TECHNICAL SPECIFICATIONS

### KSO-series II Garage Door Operator

**Connected loads:**

230 V  
200 W (in operation with lighting)  
3.9 W (out of operation without lighting)

**Door travel speed:**

0.14 m/s with "soft" start and "soft" stop

**Push and pull force:**

550 N

**Excess travel stop:**

88 secs.

**Lighting:**

1 x 40 W E14

**Control voltage:**

Low voltage below 24 V DC.

**Automatic cut-out:**

Electronic power limit through microprocessor and power sensor.

**Anti-Block system:**

Through microprocessor and RPM sensor.

**Device to prevent forced opening of door:**

Electronic back-drive prevention by permanent protection of the closed door position.

Door will automatic close after ca. 1cm detected unauthorized reverse movement.

**Protection category:**

For dry buildings only.

**Attention:**

Observe local regulations!

Always lay mains cable (230V) and control wire (low voltage) seperately.

**Attention:**

Only operate garage door when certain there is no person or object in garage door opening and travel path.

### Maintenance

This garage door operator is virtually maintenance-free.

However, all movable parts of the door and operator system should be checked regularly and kept in an easily movable condition.

The OPEN and CLOSE automatic cut-out settings should be checked regularly.

The door must be running smoothly and regularly maintained. Check the lifting regularly.

# SHORT PROGRAMMING MODEL O-NR SERIES II

## Basic Settings:

Press **P** for 2 sec. until LED **1** blinks and all others are illuminated.

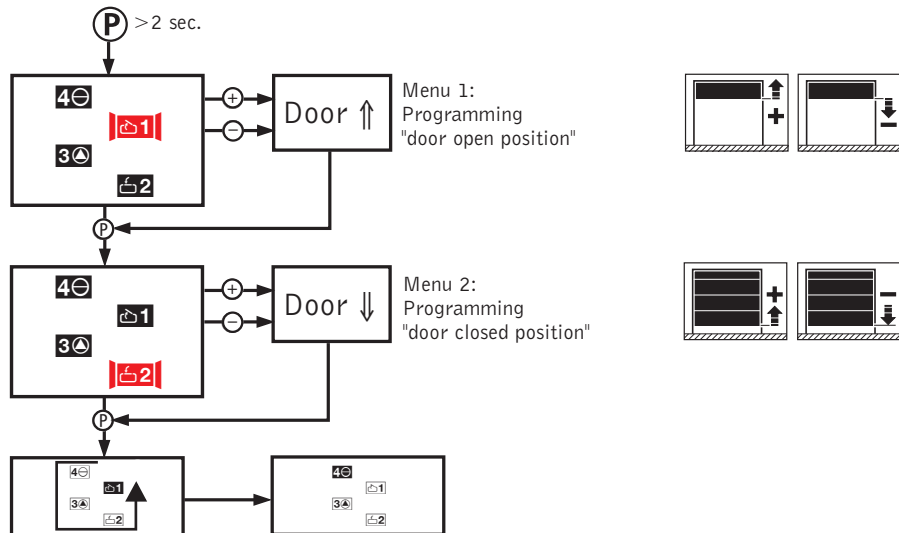

## Advanced Settings: **Level 2**

Press **P** for more than 10 sec. until LED **1** blinks rapidly and all others are illuminated.

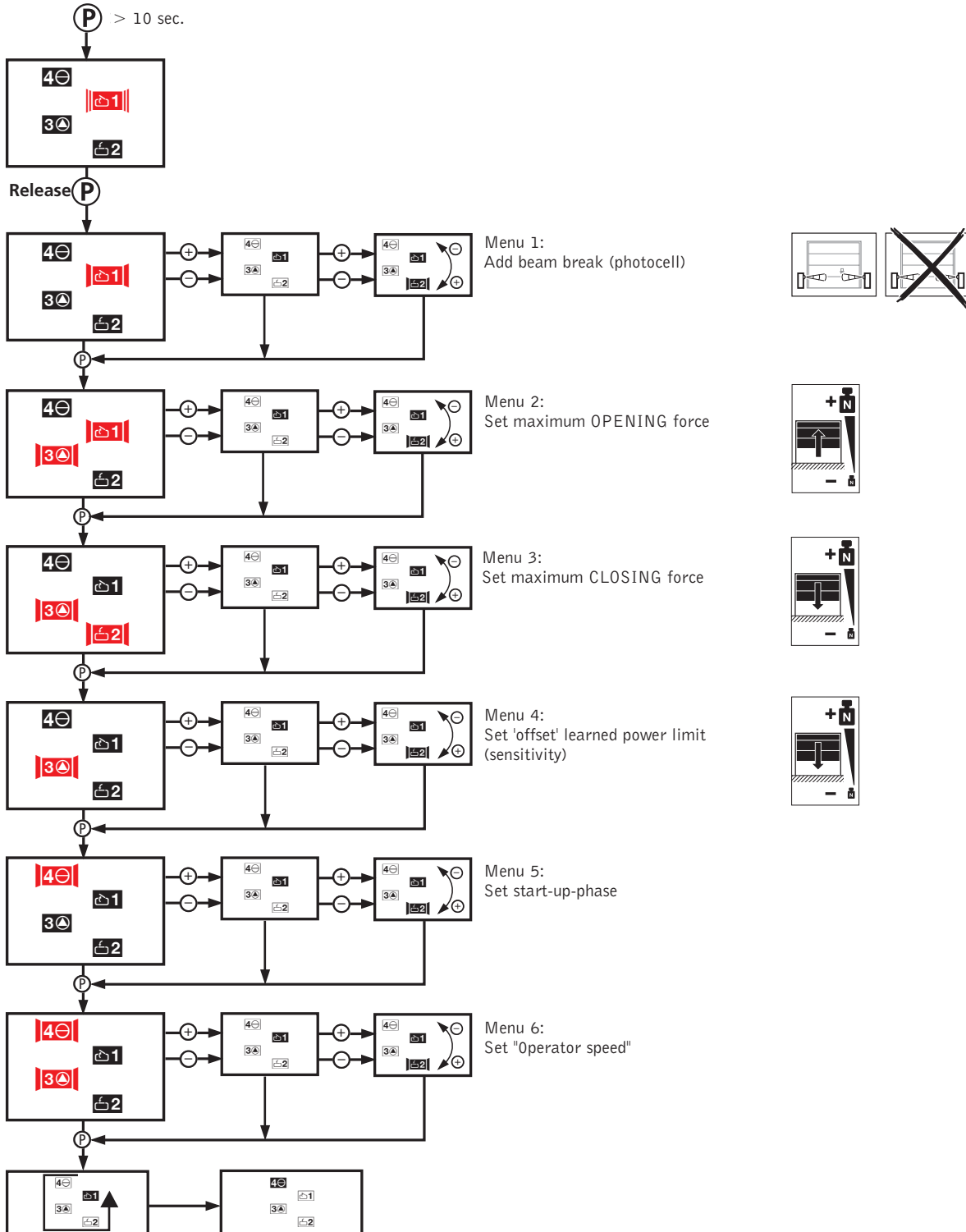

**Herstellereklæring**  
**Manufacturer's Declaration**  
**Déclaration du fabricant**  
**Verklaring van de fabrikant**  
**Declaración del fabricante**  
**Dichiarazione del produttore**

**(D)**  
 Hiermit erklären wir, daß das nachfolgend bezeichnete Produkt aufgrund seiner Konzipierung und Bauart sowie in der von uns in Verkehr gebrachten Ausführung den einschlägigen grundlegenden Sicherheits- und Gesundheitsanforderungen der EG-Richtlinie Elektromagnetische Verträglichkeit, der Maschinen-Richtlinie und der Niederspannungsrichtlinie entspricht.  
 Bei einer nicht mit uns abgestimmten Änderung der Produkte verliert diese Erklärung ihre Gültigkeit.

**(GB)**  
 We hereby declare that the product referred to below, with reference to its design, construction and to the version as marketed by us, conforms to the relevant safety and health requirements contained in the European Council Directives pertaining to electromagnetic compatibility, machines and low voltage.  
 This declaration becomes null and void in the event of modification or changes to the product not expressly agreed with us.

**(F)**  
 Par la présente, nous déclarons que le produit sous-mentionné correspond, de par sa conception et son type de construction, tout comme la version commercialisée, aux conditions fondamentales exigées pour la sécurité et la santé de la directive CE relative à la compatibilité électromagnétique, de la directive concernant les machines et de celle relative à la basse tension.  
 Cette déclaration perd toute validité en cas de modification des produits, effectuée sans notre accord.

**(NL)**  
 Hierbij verklaren wij dat het hierna genoemde product qua ontwerp en constructie alsmede de door ons op de markt gebrachte uitvoering voldoet aan de hiervoor geldende veiligheids- en gezondheidsnormen conform de Europese richtlijnen t.w.: EMC-richtlijn, Machinerichtlijn en Laagspanningsrichtlijn.  
 Ingeval van wijzigingen aan onze producten die niet met ons afgestemd zijn, verliest deze verklaring haar geldigheid.

**(E)**  
 Por la presente declaramos que el producto indicado a continuación, en base a su concepción y tipo constructivo, así como en el acabado comercializado por nosotros, cumple con los requisitos básicos obligatorios sanitarios y de seguridad de la directiva de la CE sobre compatibilidad electromagnética, la Directiva de Maquinaria y la Directiva de Baja Tensión.  
 En caso de una modificación del producto no acordada con nosotros, esta declaración perderá su validez.

**(I)**  
 Con la presente dichiariamo che il prodotto di seguito descritto, in base alla sua progettazione e tipo e nella versione da noi messa in commercio, rispetta tutti i requisiti essenziali di sicurezza e sanitari che lo concernono previsti dalla direttiva CE sulla compatibilità elettromagnetica, dalla direttiva relativa alle macchine e dalla direttiva relativa alla bassa tensione. In caso di modifica apportata senza nostra autorizzazione, la presente dichiarazione perde la propria validità.

**Produsenterklæring**  
**Fabrikanteklæring**  
**Δήλωση του κατασκευαστή**  
**Declaração do Fabricante**  
**制造商申明**



**(N)**  
 Herved erklærer vi at det i det følgende betegnede produktet på grunn av dets konsepsjon og konstruksjon i den versjonen som vi har brakt i handelen er i samsvar med de vedkommende grunnleggende krav til sikkerhet og helse i EF-direktivet Elektromagnetisk kompatibilitet, i Maskindirektivet og i Lavspenningsdirektivet.  
 Ved en endring av produktet som ikke er avstemt med oss, mister denne erklæringen sin gyldighet.

**(DK)**  
 Hermed erklærer vi, at efterfølgende opførte produkt på grund af dets koncipering og konstruktion og i den udførelse, som vi har bragt i handelen, opfylder de vedtagne grundlæggende sikkerheds- og sundhedskrav ifølge EF-Direktivet om Elektro-magnetisk kompatibilitet, Maskindirektivet og Lavspændingsdirektivet. Såfremt der foretages ændringer af produktet, der ikke er godkendt af os, bliver nærværende erklæring ugyldig.

**(RUS)**  
 настоящим объявляем, что указанная ниже продукция по своему проектированию и конструкции, а так же по используемому нами типу изготовления соответствует действующим основополагающим требованиям по безопасности и охране здоровья директив ЕС по электромагнитной совместимости, оборудованию и технике низких напряжений. В случае производства несанкционированных производителем изменений в продукции, данная декларация считается недействительной.

**(GR)**  
 Με την παρούσα δηλώνουμε ότι το προϊόν που περιγράφεται παρακάτω, σύμφωνα με το σχεδιασμό και τον τύπο κατασκευής του, στο μοντέλο που κυκλοφορεί στο εμπόριο, πληρεί όλες τις βασικές απαιτήσεις ασφαλείας και υγιεινής που προβλέπονται η Οδηγία ΕΕ σχετικά με την ηλεκτρομαγνητική συμβατότητα, η αντίστοιχη Οδηγία μηχανημάτων και η Οδηγία χαμηλής τάσης. Σε περίπτωση τροποποίησης χωρίς την έγκρισή μας, η παρούσα δήλωση παύει να ισχύει.

**(P)**  
 Declaramos por este meio que o produto abaixo descrito corresponde, pela sua concepção e modelo, tal como no modelo por nós comercializado, às respectivas exigências básicas de segurança e de saúde da Directiva CE relativa a Tolerância Electromagnética, da Directiva relativa a Maquinaria e da Directiva sobre Baixa Tensão.  
 Em caso de qualquer tipo de alteração não previamente acordada com a nossa Empresa, a presente declaração perderá a sua validade.

**(RC)**  
 我们在此申明，依据产品的设计、结构以及由我们投放市场的款式，以下产品符合欧共体有关基本安全和健康的准则要求，包括电磁兼容性准则、机器准则和低压准则。如未经我们许可而对产品进行更改，则此申明失效。

**Produkt produkt produkt προϊόν**  
**product producto producto**  
**produit prodotto Продукция 产品**  
**KSO**

Einschlägige EG-Richtlinien: EG-Richtlinie Elektromagnetische Verträglichkeit (89/336/EWG, 93/68/EWG und 93/44/EWG), Maschinen-Richtlinie (89/392/EWG, 91/368/EWG, 93/68/EWG und 93/44/EWG) und Niederspannungsrichtlinie (73/23/EWG, 93/68/EWG und 93/44/EWG).  
 Relevant European Council Directives pertaining to electromagnetic compatibility (89/336/EEC, 93/68/EEC and 93/44/EEC), machines (89/392/EEC, 91/368/EEC, 93/68/EEC and 93/44/EEC) and low voltage (73/23/EEC, 93/68/EEC and 93/44/EEC).  
 Directives CE se rapportant à la: Directive CE sur la compatibilité électromagnétique (89/336/CEE, 93/68/CEE et 93/44/CEE), de la directive concernant les machines (89/392/CEE, 91/368/CEE, 93/68/CEE et 93/44/CEE) et de celle relative à la basse tension (73/23/CEE, 93/68/CEE et 93/44/CEE).  
 Van toepassing zijnde Europese richtlijnen: EMC-richtlijn (89/336/EEG, 93/68/EEG en 93/44/EEG), Machine richtlijn (89/392/EEG, 91/368/EEG, 93/68/EEG en 93/44/EEG) en Laagspanningsrichtlijn (73/23/EEG, 93/68/EEG en 93/44/EEG).  
 Directivas de la CE obligatorias: Directiva CE sobre Compatibilidad electromagnética (89/336/MCE, 93/68/MCE y 93/44/MCE), la directiva de Maquinaria (89/392/MCE, 91/368/MCE, 93/68/MCE y 93/44/MCE) y la Directiva de Baja Tensión (73/23/MCE, 93/68/MCE y 93/44/MCE).  
 Direttive CE applicate: direttiva CE sulla compatibilità elettromagnetica (89/336/CEE, 93/68/CEE e 93/44/CEE), direttiva relativa alle macchine (89/392/CEE, 91/368/CEE, 93/68/CEE e 93/44/CEE) e direttiva relativa alla bassa tensione (73/23/CEE, 93/68/CEE e 93/44/CEE).  
 Vedkommende EF-direktiver: EF-direktiv Elektromagnetisk kompatibilitet (89/336/EWG, 93/68/EWG og 93/44/EWG), Maskindirektivet (89/392/EWG, 91/368/EWG, 93/68/EWG og 93/44/EWG) og Lavspenningsdirektivet (73/23/EWG, 93/68/EWG og 93/44/EWG).  
 Relevante EF-direktiver: EF-Direktivet om Elektromagnetisk kompatibilitet (89/336/EØF, 93/68/EØF og 93/44/EØF), Maskindirektivet (89/392/EØF, 91/368/EØF, 93/68/EØF og 93/44/EØF) og Lavspændingsdirektivet (73/23/EØF, 93/68/EØF og 93/44/EØF).  
 Соответствующие директивы ЕС: директива ЕС по электромагнитной совместимости (89/336/EWG, 93/68/EWG и 93/44/EWG), директива по оборудованию (89/392/EWG, 91/368/EWG, 93/68/EWG и 93/44/EWG) и директива по технике низких напряжений (73/23/EWG, 93/68/EWG и 93/44/EWG).  
 Σχετικές Οδηγίες ΕΕ: Οδηγία ΕΕ ηλεκτρομαγνητικής συμβατότητας (89/336/ΕΟΚ, 93/68/ΕΟΚ και 93/44/ΕΟΚ), οι Οδηγίες μηχανημάτων (89/392/ΕΟΚ, 91/368/ΕΟΚ, 93/68/ΕΟΚ και 93/44/ΕΟΚ) και οι Οδηγίες χαμηλής τάσης (73/23/ΕΟΚ, 93/68/ΕΟΚ και 93/44/ΕΟΚ).  
 Directivas CE aplicáveis: Directiva CE relativa a Tolerância Electromagnética (89/336/EWG, 93/68/EWG e 93/44/EWG), Directiva relativa a Maquinaria (89/392/EWG, 91/368/EWG, 93/68/EWG e 93/44/EWG) e Directiva sobre Baixa Tensão (73/23/EWG, 93/68/EWG e 93/44/EWG).  
 有关欧共体准则：欧共体电磁兼容性准则（89/336/EWG, 93/68/EWG 和 93/44/EWG）；机器准则（89/392/EWG, 91/368/EWG, 93/68/EWG 和 93/44/EWG）以及低压准则（73/23/EWG, 93/68/EWG 和 93/44/EWG）。

Angewandte harmonisierte Normen, insbesondere:  
 To agreed standards:  
 Normes harmonisées appliquées, tout spécialement:  
 Toegepaste geharmoniseerde normen, met name:  
 Normas armonizadas aplicadas, en especial:  
 Norme armonizzate applicate:  
 Benyttede harmoniserede normer, spesielt:  
 Anvendte harmoniserede standarder, især:  
 Соответствие единым стандартам, в частности:  
 Εφαρμοσθείσες εθνικές νόμιμες και τεχνικές προδιαγραφές ειδικότερα:  
 Normas harmonizadas aplicadas, sobretudo:  
 使用的统一标准，尤其包括：

- EN 292-1
- EN 50081-1
- EN 50082-2
- EN 55014
- EN 61000-3-2
- EN 61000-3-3
- EN 60335-1
- EN 60335-2-95
- EN 12445
- EN 12453
- EN 300220-1
- EN 301489-3
- ETS 300683
- I-ETS 300200

Angewandte nationale Normen und technische Spezifikationen, insbesondere:  
 To National standard and technical specification:  
 Normes nationales appliquées, et spécifications techniques, tout spécialement:  
 Toegepaste nationale normen en technische specificaties, met name:  
 Normas nacionales y especificaciones técnicas aplicadas, en especial:  
 Specificazioni tecniche a carattere nazionale applicate, in particolare:  
 Benyttede nasjonale normer og tekniske spesifikasjoner spesielt:  
 Anvendte nationale standarder og tekniske spesifikasjoner, især:  
 Соответствие национальным стандартам и техническим спецификациям, в частности:  
 Εφαρμοσθείσες εθνικές νόμιμες και τεχνικές προδιαγραφές ειδικότερα:  
 Normas nacionais e especificações técnicas aplicadas, sobretudo:  
 使用的国家标准和技术规格，尤其包括：

**ZH 494 April 89**  
**VDE 0700-238**

01.10.2003 pp.a. Enneking

Datum / Unterschrift

**EG-Konformitätserklärung**  
**EC Conformity Declaration**  
**Déclaration CE de conformité**  
**EG-conformiteitsverklaring**  
**Declaración CE de conformidad**  
**Dichiarazione CE di conformità**

**EF-konformitetserklæring**  
**EU-overensstemmelseserklæring**  
**Заявление о соответствии директивам ЕС**  
**ΕΟΚική δήλωση εναρμόνισης**  
**Declaração CE de Conformidade**  
**欧 共 体 符 合 标 志 申 明**



**(D)**

Hiermit erklären wir, daß das nachfolgend bezeichnete Produkt aufgrund seiner Konzipierung und Bauart sowie in der von uns in Verkehr gebrachten Ausführung den einschlägigen grundlegenden Sicherheits- und Gesundheitsanforderungen der EG-Richtlinie Elektromagnetische Verträglichkeit, der Maschinen-Richtlinie und der Niederspannungsrichtlinie entspricht.  
Bei einer nicht mit uns abgestimmten Änderung der Produkte verliert diese Erklärung ihre Gültigkeit.

**(GB)**

We hereby declare that the product referred to below, with reference to its design, construction and to the version as marketed by us, conforms to the relevant safety and health requirements contained in the European Council Directives pertaining to electromagnetic compatibility, machines and low voltage.  
This declaration becomes null and void in the event of modification or changes to the product not expressly agreed with us.

**(F)**

Par la présente, nous déclarons que le produit sous-mentionné correspond, de par sa conception et son type de construction, tout comme la version commercialisée, aux conditions fondamentales exigées pour la sécurité et la santé de la directive CE relative à la compatibilité électromagnétique, de la directive concernant les machines et de celle relative à la basse tension.  
Cette déclaration perd toute validité en cas de modification des produits, effectuée sans notre accord.

**(NL)**

Hierbij verklaren wij dat het hierna genoemde product qua ontwerp en constructie alsmede de door ons op de markt gebrachte uitvoering voldoet aan de hiervoor geldende veiligheids- en gezondheidsnormen conform de Europese richtlijnen t.w.: EMC-richtlijn, Machinerichtlijn en Laagspanningsrichtlijn.  
Ingeval van wijzigingen aan onze producten die niet met ons afgestemd zijn, verliest deze verklaring haar geldigheid.

**(E)**

Por la presente declaramos que el producto indicado a continuación, en base a su concepción y tipo constructivo, así como en el acabado comercializado por nosotros, cumple con los requisitos básicos obligatorios sanitarios y de seguridad de la directiva de la CE sobre compatibilidad electromagnética, la Directiva de Maquinaria y la Directiva de Baja Tensión.  
En caso de una modificación del producto no acordada con nosotros, esta declaración perderá su validez.

**(I)**

Con la presente dichiariamo che il prodotto di seguito descritto, in base alla sua progettazione e tipo e nella versione da noi messa in commercio, rispetta tutti i requisiti essenziali di sicurezza e sanitari che lo concernono previsti dalla direttiva CE sulla compatibilità elettromagnetica, dalla direttiva relativa alle macchine e dalla direttiva relativa alla bassa tensione. In caso di modifica apportata senza nostra autorizzazione, la presente dichiarazione perde la propria validità.

**(N)**

Herved erklærer vi at det i det følgende betegnede produktet på grunn av dets konsepsjon og konstruksjon i den versjonen som vi har brakt i handelen er i samsvar med de vedkommende grunnleggende krav til sikkerhet og helse i EF-direktivet Elektromagnetisk kompatibilitet, i Maskindirektivet og i Lavspenningsdirektivet.  
Ved en endring av produktet som ikke er avstemt med oss, mister denne erklæringen sin gyldighet.

**(DK)**

Hermed erklærer vi, at efterfølgende opførte produkt på grund af dets koncipering og konstruktion og i den udførelse, som vi har bragt i handelen, opfylder de vedtagne grundlæggende sikkerheds- og sundhedskrav ifølge EF-Direktivet om Elektro-magnetisk kompatibilitet, Maskindirektivet og Lavspændingsdirektivet. Såfremt der foretages ændringer af produktet, der ikke er godkendt af os, bliver nærværende erklæring ugyldig.

**(RUS)**

настоящим объявляем, что указанная ниже продукция по своему проектированию и конструкции, а так же по исполняемому нами типу изготовления соответствует действующим основополагающим требованиям по безопасности и охране здоровья директив ЕС по электромагнитной совместимости, оборудованию и технике низких напряжений. В случае производства несанкционированных производителем изменений в продукции, данная декларация считается недействительной.

**(GR)**

Με την παρούσα δηλώνουμε ότι το προϊόν που περιγράφεται παρακάτω, σύμφωνα με το σχεδιασμό και τον τύπο κατασκευής του, στο μοντέλο που κυκλοφορεί στο εμπόριο, πληρεί όλες τις βασικές απαιτήσεις ασφαλείας και υγιεινής που προβλέπονται η Οδηγία ΕΕ σχετικά με την ηλεκτρομαγνητική συμβατότητα, η αντίστοιχη Οδηγία μηχανημάτων και η Οδηγία χαμηλής τάσης. Σε περίπτωση τροποποίησης χωρίς την έγκρισή μας, η παρούσα δήλωση παύει να ισχύει.

**(P)**

Declaramos por este meio que o produto abaixo descrito corresponde, pela sua concepção e modelo, tal como no modelo por nós comercializado, às respectivas exigências básicas de segurança e de saúde da Directiva CE relativa a Tolerância Electromagnética, da Directiva relativa a Maquinaria e da Directiva sobre Baixa Tensão.  
Em caso de qualquer tipo de alteração não previamente acordada com a nossa Empresa, a presente declaração perderá a sua validade.

**(RC)**

我们在此申明，依据产品的设计、结构以及由我们投放市场的款式，以下产品符合欧共体有关基本安全和健康的准则要求，包括电磁兼容性准则、机器准则和低压准则。  
如未经我们许可而对产品进行更改，则此申明失效。

**Προϊόν**  
**Produkt produkt produkt προϊόν**  
**product producto produkt produto**  
**produit prodotto Продукция 产品**

Einschlägige EG-Richtlinien: EG-Richtlinie Elektromagnetische Verträglichkeit (89/336/EWG, 93/68/EWG und 93/44/EWG), Maschinen-Richtlinie (89/392/EWG, 91/368/EWG, 93/68/EWG und 93/44/EWG) und Niederspannungsrichtlinie (73/23/EWG, 93/68/EWG und 93/44/EWG).  
Relevant European Council Directives pertaining to electromagnetic compatibility (89/336/EEC, 93/68/EEC and 93/44/EEC), machines (89/392/EEC, 91/368/EEC, 93/68/EEC and 93/44/EEC) and low voltage (73/23/EEC, 93/68/EEC and 93/44/EEC).  
Directives CE se rapportant à la: Directive CE sur la compatibilité électromagnétique (89/336/CEE, 93/68/CEE et 93/44/CEE), de la directive concernant les machines (89/392/CEE, 91/368/CEE, 93/68/CEE et 93/44/CEE) et de celle relative à la basse tension (73/23/CEE, 93/68/CEE et 93/44/CEE).  
Van toepassing zijnde Europese richtlijnen: EMC-richtlijn (89/336/EEG, 93/68/EEG en 93/44/EEG), Machine richtlijn (89/392/EEG, 91/368/EEG, 93/68/EEG en 93/44/EEG) en Laagspanningsrichtlijn (73/23/EEG, 93/68/EEG en 93/44/EEG).  
Directivas de la CE obligatorias: Directiva CE sobre Compatibilidad electromagnética (89/336/MCE, 93/68/MCE y 93/44/MCE), la directiva de Maquinaria (89/392/MCE, 91/368/MCE, 93/68/MCE y 93/44/MCE) y la Directiva de Baja Tensión (73/23/MCE, 93/68/MCE y 93/44/MCE).  
Direttive CE applicate: direttiva CE sulla compatibilità elettromagnetica (89/336/CEE, 93/68/CEE e 93/44/CEE), direttiva relativa alle macchine (89/392/CEE, 91/368/CEE, 93/68/CEE e 93/44/CEE) e direttiva relativa alla bassa tensione (73/23/CEE, 93/68/CEE e 93/44/CEE).  
Vedkommende EF-direktiver: EF-direktiv Elektromagnetisk kompatibilitet (89/336/EWG, 93/68/EWG og 93/44/EWG), Maskindirektivet (89/392/EWG, 91/368/EWG, 93/68/EWG og 93/44/EWG) og Lavspenningsdirektivet (73/23/EWG, 93/68/EWG og 93/44/EWG).  
Relevante EF-direktiver: EF-Direktivet om Elektromagnetisk kompatibilitet (89/336/EØF, 93/68/EØF og 93/44/EØF), Maskindirektivet (89/392/EØF, 91/368/EØF, 93/68/EØF og 93/44/EØF) og Lavspændingsdirektivet (73/23/EØF, 93/68/EØF og 93/44/EØF).  
Соответствующие директивы ЕС: директива ЕС по электромагнитной совместимости (89/336/EWG, 93/68/EWG и 93/44/EWG), директива по оборудованию (89/392/EWG, 91/368/EWG, 93/68/EWG и 93/44/EWG) и директива по технике низких напряжений (73/23/EWG, 93/68/EWG и 93/44/EWG).  
Σχετικές Οδηγίες ΕΕ: Οδηγία ΕΕ ηλεκτρομαγνητικής συμβατότητας (89/336/ΕΟΚ, 93/68/ΕΟΚ και 93/44/ΕΟΚ), οι Οδηγίες μηχανημάτων (89/392/ΕΟΚ, 91/368/ΕΟΚ, 93/68/ΕΟΚ και 93/44/ΕΟΚ) και οι Οδηγίες χαμηλής τάσης (73/23/ΕΟΚ, 93/68/ΕΟΚ και 93/44/ΕΟΚ).  
Directivas CE aplicáveis: Directiva CE relativa a Tolerância Electromagnética (89/336/EWG, 93/68/EWG e 93/44/EWG), Directiva relativa a Maquinaria (89/392/EWG, 91/368/EWG, 93/68/EWG e 93/44/EWG) e Directiva sobre Baixa Tensão (73/23/EWG, 93/68/EWG e 93/44/EWG).  
有关欧共体准则：欧共体电磁兼容性准则（89/336/EWG, 93/68/EWG 和 93/44/EWG），机器准则（89/392/EWG, 91/368/EWG, 93/68/EWG 和 93/44/EWG）以及低压准则（73/23/EWG, 93/68/EWG 和 93/44/EWG）。

Angewandte harmonisierte Normen, insbesondere:  
To agreed standards:  
Normes harmonisées appliquées, tout spécialement:  
Toegepaste geharmoniseerde normen, met name:  
Normas armonizadas aplicadas, en especial:  
Norme armonizzate applicate:  
Benyttede harmoniserede normer, spesielt:  
Anvendte harmoniserede standarder, især:  
Соответствие единым стандартам, в частности:  
Εφαρμοσθείσες εθνικές νόμιμες και τεχνικές προδιαγραφές ειδικότερα:  
Normas armonizadas aplicadas, sobretudo:  
使用的统一标准，尤其包括：

EN 292-1  
EN 50081-1  
EN 50082-1  
EN 55014  
EN 61000-3-2  
EN 61000-3-3  
EN 60335-1  
EN 60335-2-95  
EN 12445  
EN 12453  
EN 300220-1  
EN 301489-3  
ETS 300683  
I-ETS 300200

Angewandte nationale Normen und technische Spezifikationen, insbesondere:  
To National standard and technical specification:  
Normes nationales appliquées, et spécifications techniques, tout spécialement:  
Toegepaste nationale normen en technische specificaties, met name:  
Normas nacionales y especificaciones técnicas aplicadas, en especial:  
Specificazioni tecniche a carattere nazionale applicate, in particolare:  
Benyttede nasjonale normer og tekniske spesifikasjoner spesielt:  
Anvendte nationale standarder og tekniske spesifikasjoner, især:  
Соответствие национальным стандартам и техническим спецификациям, в частности:  
Εφαρμοσθείσες εθνικές νόμιμες και τεχνικές προδιαγραφές ειδικότερα:  
Normas nacionais e especificações técnicas aplicadas, sobretudo:  
使用的国家标准和技术规格，尤其包括：

ZH 494 April 89  
VDE 0700-238

Datum / Unterschrift







**GB**

**Copyright.**

No part of this manual may be reproduced without prior approval.  
Subject to alterations in the interests of technical progress.